

Article number: 20476B10B10AELS

Description: E+G T-clamp mounting - GN 476-B10-B10-A-ELS

Measures

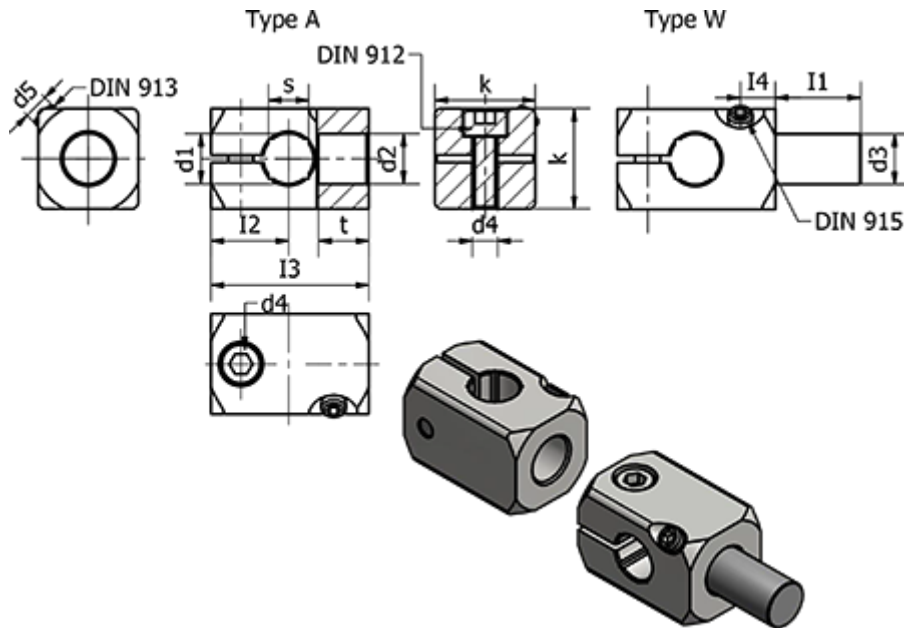

Clamping kit for d4 = GN 511-M5-20	l3	= 31.5	
d1	= 10	l4	= 7
d2	= 10	k	= 20
d3	=	s	= 8
d4	= M5	t	= 10
d5	= M5	Weight (g)	= 150
l1	= 17		
l2	= 15.5		